

DIAGONAL VENTILATOR DV70N⁰2.8

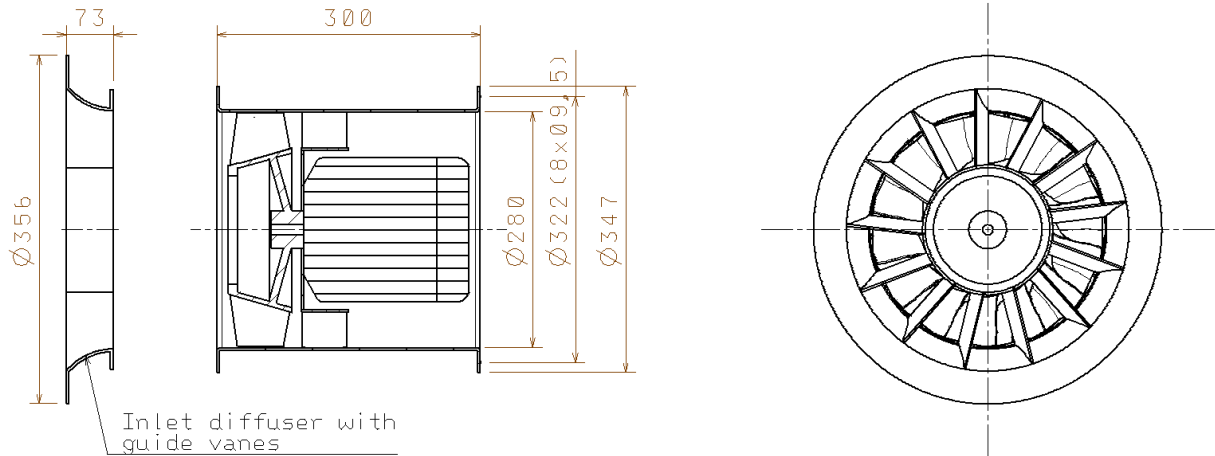

DV70N⁰2.8
P=0.25 kW at 0°
n=1350 min⁻¹

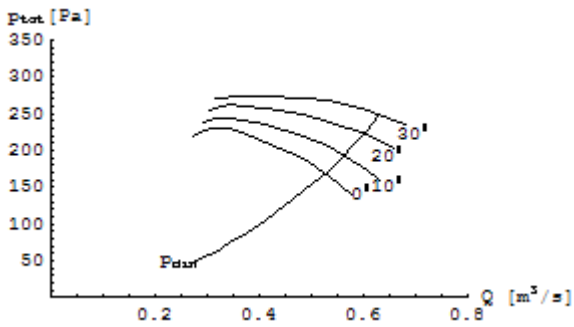

DV70N⁰2.8
P=1.1 kW at 0°
n=2800 min⁻¹

